

Classic Wrap-Arounds

For cylindrical door locks with 2¹/₈" hole.

Number	Backset	Door Thickness	Dimensions	Finishes
CW-1	2 ³ / ₈ "	1 ³ / ₈ "	4" x 9"	PB
CW-2	2 ³ / ₈ "	1 ³ / ₄ "	4" x 9"	PB, S
CW-4	2 ³ / ₄ "	1 ³ / ₄ "	4 ¹ / ₄ " x 9"	AB, PB, S

22 (.032) gauge steel

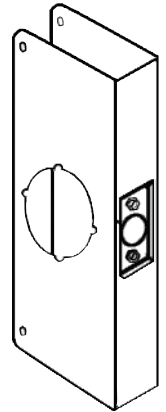

For deadbolts with 1¹/₂" hole.

Number	Backset	Door Thickness	Dimensions	Finishes
CW-6	2 ³ / ₈ "	1 ³ / ₄ "	4" x 4 ¹ / ₂ "	S

22 (.032) gauge steel

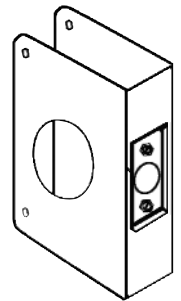

For cylindrical door locks with 2¹/₈" hole.

Number	Backset	Door Thickness	Dimensions	Finishes
CW-61	2 ³ / ₈ "	1 ³ / ₄ "	4" x 4 ¹ / ₂ "	S
CW-81	2 ³ / ₄ "	1 ³ / ₄ "	4 ¹ / ₄ " x 4 ¹ / ₂ "	PB, S

22 (.032) gauge steel

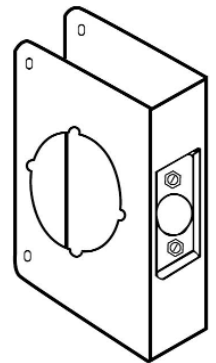

Finishes: AB — Antique Brass — 609
 PB — Polished Brass — 605
 S — Stainless Steel — 630

For double lock combination locksets with 1¹/₂" hole on top and 2¹/₈" hole on bottom with 4" centers.

Number	Backset	Door Thickness	Dimensions	Finishes
CW-264	2 ³ / ₈ "	1 ³ / ₄ "	4" x 9"	PB
CW-484	2 ³ / ₄ "	1 ³ / ₄ "	4 ¹ / ₄ " x 9"	AB, PB, S

22 (.032) gauge steel

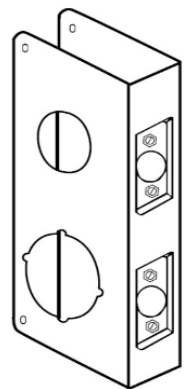

Classic Wrap-Arounds

Blank wrap-around with trim screw holes.

Number	Backset	Door Thickness	Dimensions	Finishes
CW-40	–	1 ³ / ₄ "	4 ¹ / ₄ " x 9"	S
CW-80	–	1 ³ / ₄ "	4 ¹ / ₄ " x 4 ¹ / ₂ "	AB, PB, S

22 (.032) gauge steel

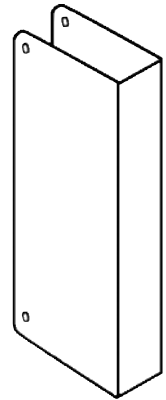

For use with heavy duty grade 1 & grade 2 key-in-levers.

Number	Backset	Door Thickness	Dimensions	Finishes
CW-4-2	2 ³ / ₄ "	1 ³ / ₄ "	4 ³ / ₄ " x 9"	BZ, S

22 (.032) gauge steel

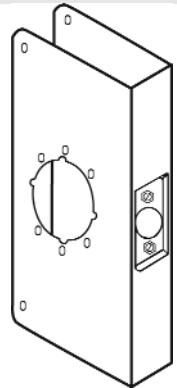

Finishes:
 AB — Antique Brass — 609
 BZ — Satin Bronze — 612
 PB — Polished Brass — 605
 S — Stainless Steel — 630

Fits Simplex/Unican 1000 series & 4000 series.

Number	Backset	Door Thickness	Dimensions	Finishes
CW-9	2 ³ / ₄ "	1 ³ / ₄ "	5" x 9"	PB, S
CW-15	2 ³ / ₄ "	1 ³ / ₄ "	5" x 15"	PB, S

22 (.032) gauge steel

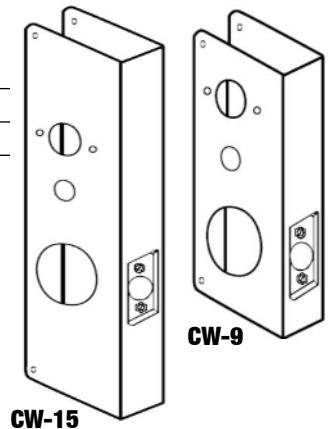

For conversion of Simplex 1000 series & Alarm Lock DL2500, 2700/T2 & 3000 series.

Number	Backset	Door Thickness	Dimensions	Finishes
CW-14-2	2 ³ / ₄ "	1 ³ / ₄ "	5" x 14"	S

22 (.032) gauge steel

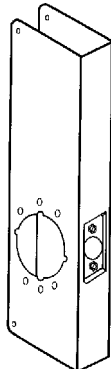

Finishes:
 PB — Polished Brass — 605
 S — Stainless Steel — 630

Latch Protectors

For aluminum entrance doors.

Number	Dimensions	Finishes
LP-307	2 ⁵ / ₈ " x 7" x 1/ ₈ "	SL

- Reversible.
- 12 (.104) gauge steel.
- Fits over cylinder — **lock removal not required.**
- Hand carriage bolt and rivet supplied.

America's favorite for out-swinging doors — completely covers the strike plate.

Number	Dimensions	Finishes
LP-211	3" x 11"	PC

- Furnished with carriage bolts, washers and acorn capnuts.
- 12 (.104) gauge steel.
- Fits 2³/₄" and 2³/₈" backsets.

For key-in knob locksets on outswinging doors.

Number	Dimensions	Finishes
LP-207	2 ³ / ₄ " x 7"	SL

- Furnished with carriage bolts, washers and acorn cap nuts for safety and strength.
- 12 (.104) gauge steel.

Commercial type for out-swing doors.

Number	Dimensions	Finishes
CLP-106	2 ¹ / ₈ " x 6"	32D

- 6" for key-in-knobs.
- 10" for mortise locks.
- Architectural design.
- Concealed welded studs with fasteners.
- 12 (.104) gauge steel.

For key-in-lever locks with up to 3¹/₄" escutcheon.

Number	Dimensions	Finishes
BLP-207	3 ¹ / ₄ " x 7"	SL

- Works with up to 3¹/₄" rose.
- Concealed welded studs with fasteners.

Finishes: PC — Prime Coated
SL — Silver Coated

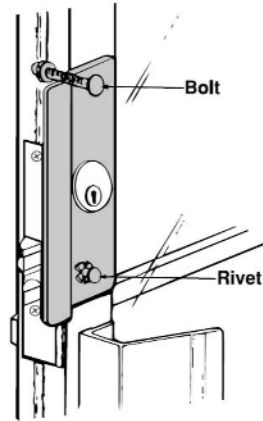

LP-307

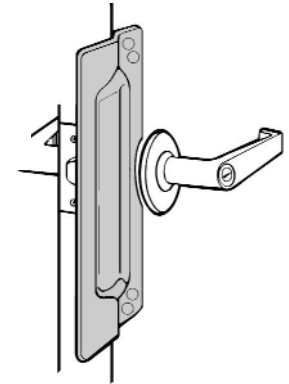

LP-211

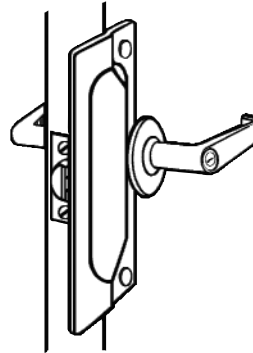

LP-207

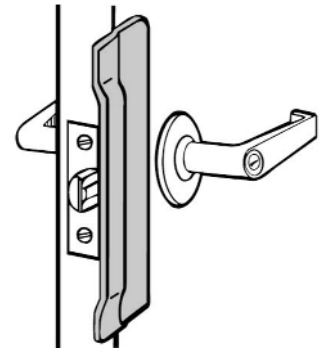

CLP-106

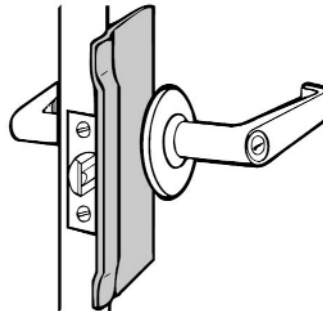

BLP-207



Top Notch Distributors, Inc.

Serving North America

Pennsylvania
800-233-4210
Fax: 800-854-4146

Missouri
800-211-4607
Fax: 800-211-4608

Nevada
800-722-4210
Fax: 800-248-3620

Texas
866-693-6903
Fax: 866-693-6904

www.topnotch.bz • sales@topnotch.bz

ANSI & Security Strikes

ANSI STRIKE

BLANK STRIKES

Number	Dimensions	Finishes
BS-161	4 ⁷ / ₈ " x 1 ¹ / ₄ "	32D

13 (.095) gauge steel.

MORTISE STRIKES

Number	Dimensions	Finishes
MST-161	4 ⁷ / ₈ " x 1 ¹ / ₄ "	BP
MST-261	4 ⁷ / ₈ " x 1 ¹ / ₄ "	SL

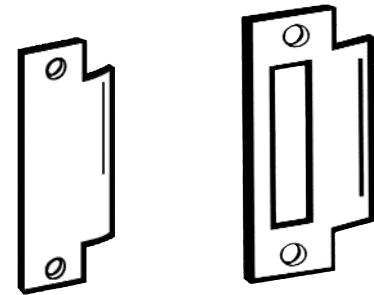

BS-161

**MST 161
MST 261**

REPLACEMENT STRIKE

T-STRIKE

Number	Dimensions	Finishes
TS-234	2 ³ / ₄ " x 1 ¹ / ₈ "	3, 32D

18 (.050) gauge steel.

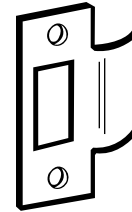

2³/₄" EXTENDED LIP STRIKE

Number	Dimensions	Finishes
EL-202	2 ³ / ₄ " x 2"	BP
EL-225	2 ³ / ₄ " x 2 ¹ / ₂ "	BP

13 (.095) gauge steel.

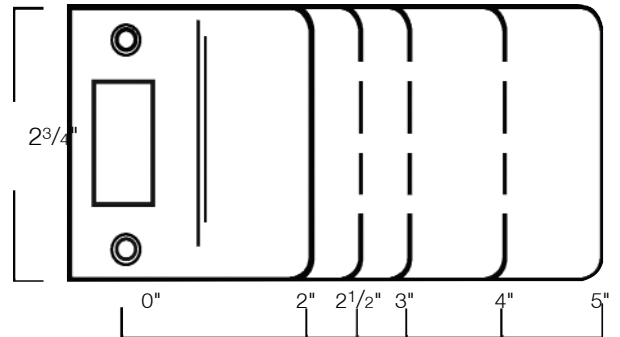

2¹/₄" EXTENDED LIP STRIKE

Number	Dimensions	Finishes
EL-102	2 ¹ / ₄ " x 2"	DU, 3, 5, 15, 15A, 32D
EL-103	2 ¹ / ₄ " x 3"	DU, 3, 15, 32D
EL-104	2 ¹ / ₄ " x 4"	DU, 3, 15
EL-115	2 ¹ / ₄ " x 1 ¹ / ₂ "	DU, 3, 5, 15, 15A, 32D
EL-125	2 ¹ / ₄ " x 2 ¹ / ₂ "	DU, 3, 15, 15A, 32D
EL-175	2 ¹ / ₄ " x 1 ³ / ₄ "	DU, 3, 5, 15, 15A, 32D

18 (.050) gauge steel.

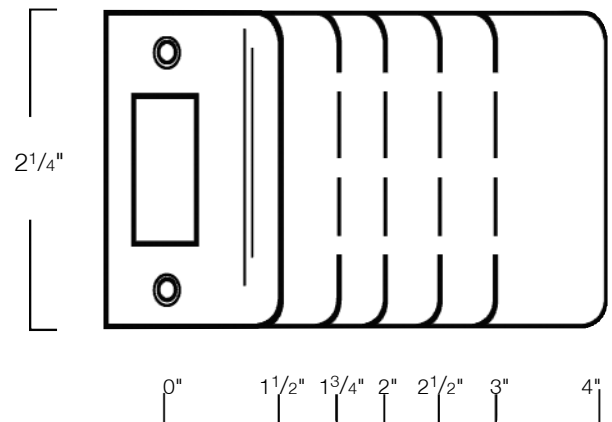

NOTE: EL-102 Series also available with radius corners. In the following finishes only: 605, 630, DU.

Finishes:

BP — SteelBrassPlated

5 — AntiqueBrass — 609

32D — SatinStainlessSteel—630

DU — DuroCoated

15 — DullNickelPlate — 619

3 — PolishedBrass — 605

15A — AntiqueNickelPlate — 620



Top Notch Distributors, Inc.

Serving North America

Pennsylvania
800-233-4210
Fax: 800-854-4146

Missouri
800-211-4607
Fax: 800-211-4608

Nevada
800-722-4210
Fax: 800-248-3620

Texas
866-693-6903
Fax: 866-693-6904

www.topnotch.bz • sales@topnotch.bz

ANSI & Security Strikes

4⁷/₈" EXTENDED LIP ANSI STRIKE

Number	Dimensions	Finishes
EST-102	4 ⁷ / ₈ " x 2"	3, 32D

13 (.095) gauge steel.

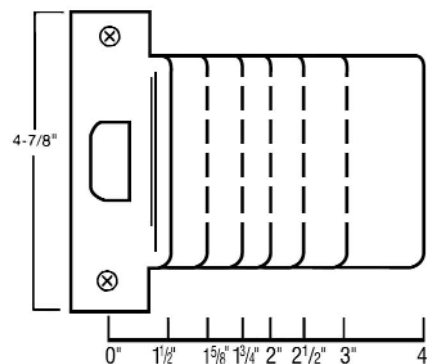

2³/₄" EXTENDED LIP T-STRIKE

Number	Dimensions	Finishes
ETS-102	2 ³ / ₄ " x 2"	3, 32D
ETS-125	2 ³ / ₄ " x 2 ¹ / ₂ "	3, 32D

18 (.050) gauge steel.

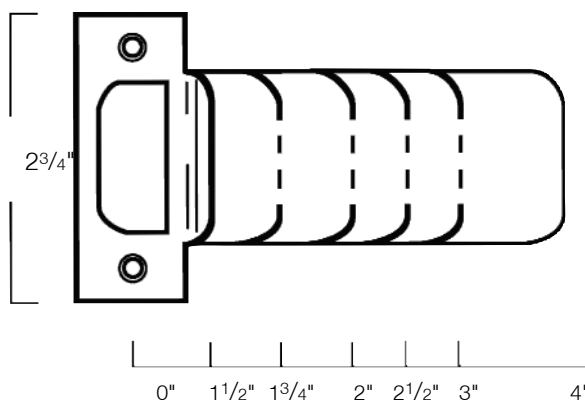

THIMBLE STRIKE

Number	Dimensions	Finishes
TS-100	1" Diameter	BP, CP

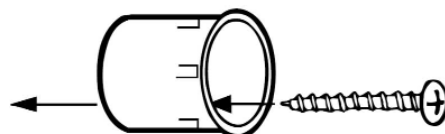

SECURITY STRIKE

Number	Dimensions	Finishes
2-SDS	4 ⁷ / ₈ " x 1 ¹ / ₄ "	BP

Finishes:
 CP — Chrome Plated
 BP — Steel Brass Plated
 3 — Polished Brass — 605
 32D — Satin Stainless Steel — 630

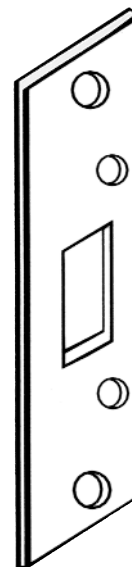

Filler Plates

FRAME FILLER PLATES

Number	Dimensions	Finishes
BTS-160	2 ³ / ₄ " x 1 ¹ / ₂ "	PC
FS-260	4 ⁷ / ₈ " x 1 ¹ / ₄ "	PC

T-strike with cut out.
BTS-160-PC

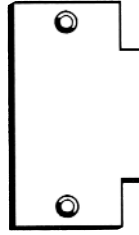

ANSI Strike cut out.
FS-260-PC



DOOR FILLER PLATES

Number	Dimensions	Finishes
CV-86	8" x 1 ¹ / ₄ "	PC
EF-86	8" x 1 ¹ / ₄ " x ³ / ₁₆ "	PC
EF-160	2 ¹ / ₄ " x 1"	BP, PC
EF-161	2 ¹ / ₄ " x 1 ¹ / ₈ "	BP, PC
SHF-45	4 ¹ / ₂ " x 1 ¹ / ₂ "	PC

Converts 86 cut out to 161.
CV-86



86 cut out.
EF-86



Door hinge cut out.
SHF-45



160 cut out.
EF-160
161 cut out.
EF-161



HOLE FILLER PLATES

Number	Dimensions	Finishes
AR-335	3 ¹ / ₂ " Diameter	605, 613, 630
BF-161	2 ⁵ / ₈ " Diameter	BP, PC, SL

Allows for use of levers on 1³/₈" door.
AR-335

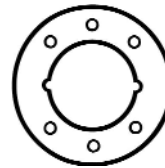

Covers up to 2¹/₈" hole.
BF-161

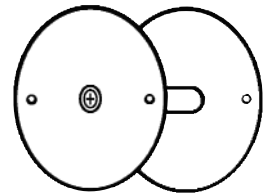

Finishes:
BP — Steel Brass Plated
PC — Prime Coated
SL — Silver Coated
3 — Polished Brass — 605
10B — Oil Rubbed Bronze — 613
32D — Satin Stainless Steel — 630

Serving North America

Pennsylvania
800-233-4210
Fax: 800-854-4146

Missouri
800-211-4607
Fax: 800-211-4608

Nevada
800-722-4210
Fax: 800-248-3620

Texas
866-693-6903
Fax: 866-693-6904

Accessory Hardware

DOOR VIEWERS

Number	View Dimensions	Finishes
DV-90	160 Degrees	605, 626
ULDV-90	160 Degrees	605, 626
DV-180	180 Degrees	605, 626
ULDV-180	180 Degrees	605, 626

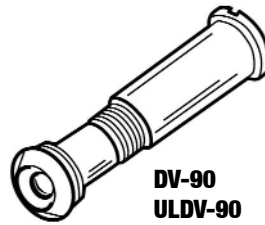

**DV-90
ULDV-90**

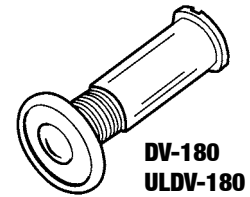

**DV-180
ULDV-180**

POCKET DOOR LOCKS

Number	Dimensions	Finishes
PDL-100	2 1/2" x 2 3/4"	605, 609, 613, 619, 620, 625, 626
PDL-101	2 1/2" x 2 3/4"	605, 609, 613, 619, 620, 625, 626

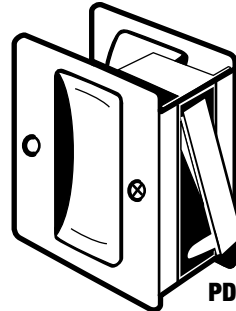

PDL-100

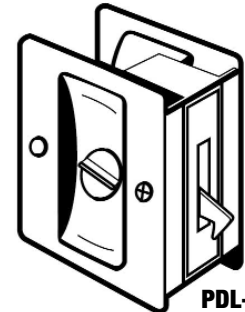

PDL-101

SCAR PLATES USED TO CONVERT 2 3/8" TO 2 3/4" BACKSET

Number	Dimensions	Finishes
SP-135	3 1/2" O.D.	605, 609, 630
DSP-135	3 1/2" O.D.	630

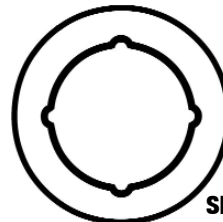

SP-135

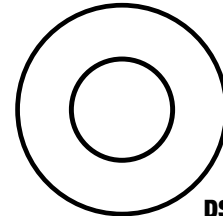

DSP-135

SPRING BASE STOPS

Number	Projection	Finishes
1508	3"	619, 620
1509	3 1/8"	605, 619
1510	3 3/4"	619, 620



1508

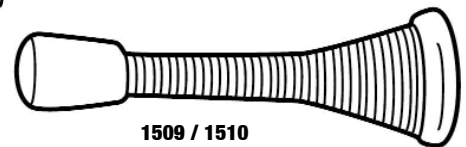

1509 / 1510

KICK PLATE

Number	Dimensions	Finishes
J102	6" x 34"	613, 619
J102	8" x 34"	619
J106	10" x 34"	Clear

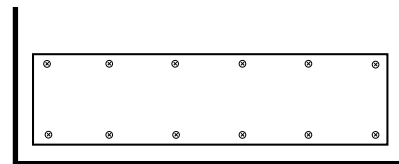

HINGE STOP

Number	Material	Finishes
1503	Cast Zinc	605, 619

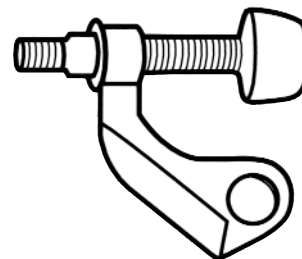

Finishes: 605 — Brass
619 — Dull Nickel Plate
630 — Satin Stainless Steel

609 — Antique Brass
620 — Antique Nickel Plate

613 — Satin Bronze
626 — Dull Brass Chrome



Top Notch Distributors, Inc.

Serving North America

Pennsylvania
800-233-4210
Fax: 800-854-4146

Missouri
800-211-4607
Fax: 800-211-4608

Nevada
800-722-4210
Fax: 800-248-3620

Texas
866-693-6903
Fax: 866-693-6904

www.topnotch.bz • sales@topnotch.bz

Notes:



Top Notch Distributors, Inc.

Serving North America

Pennsylvania
800-233-4210
Fax: 800-854-4146

Missouri
800-211-4607
Fax: 800-211-4608

Nevada
800-722-4210
Fax: 800-248-3620

Texas
866-693-6903
Fax: 866-693-6904

www.topnotch.bz • sales@topnotch.bz